



HIKU European Cup Juniors Leibnitz 2012

(AUT Leibnitz, 02-03 June 2012)

-55 kg

28 Judoka

POOL A

1	FERARIU, Alex	ROU	1	FERARIU, Alex	100 / 000 s1	2:26
17	MAKSA, Balazs	HUN	17	FERARIU, Alex	100 / 000	2:53
9	PORA, Daniel	AUT	2	CAVALLO, Luca	000 s1 / 010	0:0
25	CAVALLO, Luca	ITA	25	FERARIU, Alex	100 s1 / 000 s1	2:50
5	SCHILDERMANS, Joran	BEL	3	PLESNIK, Rok	000 / 100	0:0
21	PLESNIK, Rok	SLO	18	SMOLANSKY, Guy	001 s2 / 102 s1	0:3
13	SMOLANSKY, Guy	ISR	4	SMOLANSKY, Guy		
29						

Pool A - Winner
Vainqueur / Sieger

POOL B

3	REVOL, Cedric	FRA	5	SEIDUALY, Assylzhan	000 / 101 s1	0:56
19	SEIDUALY, Assylzhan	KAZ	19	SEIDUALY, Assylzhan	010 / 000	0:0
11	BAUER, Bastian	GER	6	BAUER, Bastian	101 / 000 s2	1:26
27	HAUSVICKA, Dario	CRO	20	ALMAMMADOV, Rasim	000 sH / 100	3:2
7	MASS, Mathias	AUT	7	MASS, Mathias		
23						
15	BARTHA, Akos	HUN	8	ALMAMMADOV, Rasim	000 s1 / 101	0:40
31	ALMAMMADOV, Rasim	AZE				

Pool B - Winner
Vainqueur / Sieger

POOL C

2	SADIGOV, Mehman	AZE	9	SADIGOV, Mehman	100 / 000 s1	2:10
18	SUNDOV, Tino	CRO	21	SADIGOV, Mehman	101 / 000	1:50
10	WILDNER, Lorenz	AUT	10	MAEKELBERG, Karim	000 s1 / 010 s1	0:0
26	MAEKELBERG, Karim	BEL	27	SADIGOV, Mehman	100 / 000	2:11
6	WEIDLINGER, Lukas	AUT	11	WEIDLINGER, Lukas		
22						
14	ARIE, Ori	ISR	12	ARIE, Ori	100 / 000 sH	2:34
30	ALIPIEV, Valentin	BUL	22	ARIE, Ori	000 / 100	3:5

Pool C - Winner
Vainqueur / Sieger

POOL D

4	QUERTINMONT, Adrien	BEL	13	QUERTINMONT, Adrien	110 s1 / 000	1:27
20	GIZAT, Zhandos	KAZ	23	QUERTINMONT, Adrien	010 / 000 s1	0:0
12	STEFAN, Autengruber	AUT	14	STEFAN, Autengruber		
28						
8	REITER, Lukas	AUT	15	REITER, Lukas	100 / 000	2:19
24	GARD, Balazs	HUN	24	REITER, Lukas	100 / 000	0:18
16	ZABARI, Topaz	ISR	16	FERRETTI, Andrea	000 / 100 s1	2:32
32	FERRETTI, Andrea	ITA				

Pool D - Winner
Vainqueur / Sieger

SADIGOV, Mehman
000 / 002 s1 0:0

1.

SADIGOV, Mehman
010 s1 / 000 0:0

Results	
Résultat / Platzierungen	
1.	SADIGOV, Mehman AZE
2.	ALMAMMADOV, Rasim AZE
3.	QUERTINMONT, Adrien BEL
3.	MAEKELBERG, Karim BEL
5.	SEIDUALY, Assylzhan KAZ
5.	FERARIU, Alex ROU
7.	CAVALLO, Luca ITA
7.	REITER, Lukas AUT

Repechage / Trostrunde

[A1]	MAKSA, Balazs	HUN	29	CAVALLO, Luca	001 s3 / 010	0:0	33	CAVALLO, Luca	001 / 000 s2	0:0
[A2]	CAVALLO, Luca	ITA	[A3]	SMOLANSKY, Guy			39	SEIDUALY, Assylzhan	000 / 100	3:19
[B1]	BARTHA, Akos	HUN	[B3]	SEIDUALY, Assylzhan	000 s2 / 002	0:0	[38]	QUERTINMONT, Adrien		
[B2]	MASS, Mathias	AUT	30	BARTHA, Akos	100 / 000	3:26	41	QUERTINMONT, Adrien	000 s2 / 001	0:0
[C1]	SUNDOV, Tino	CRO	31	MAEKELBERG, Karim	000 s1 / 011	0:0	35	MAEKELBERG, Karim	100 / 000 s1	1:1
[C2]	MAEKELBERG, Karim	BEL	[C3]	ARIE, Ori			40	MAEKELBERG, Karim	000 / 000 s1	0:0
[D1]	GIZAT, Zhandos	KAZ	32	GIZAT, Zhandos	001 / 000	0:0	36	REITER, Lukas	000 / 010	0:0
[D2]	STEFAN, Autengruber	AUT	[D3]	REITER, Lukas			[37]	FERARIU, Alex	001 s1 / 000 s2	0:0

3.

3.



HIKU European Cup Juniors Leibnitz 2012

(AUT Leibnitz, 02-03 June 2012)

A/B

-66 kg
65 Judoka

POOL A

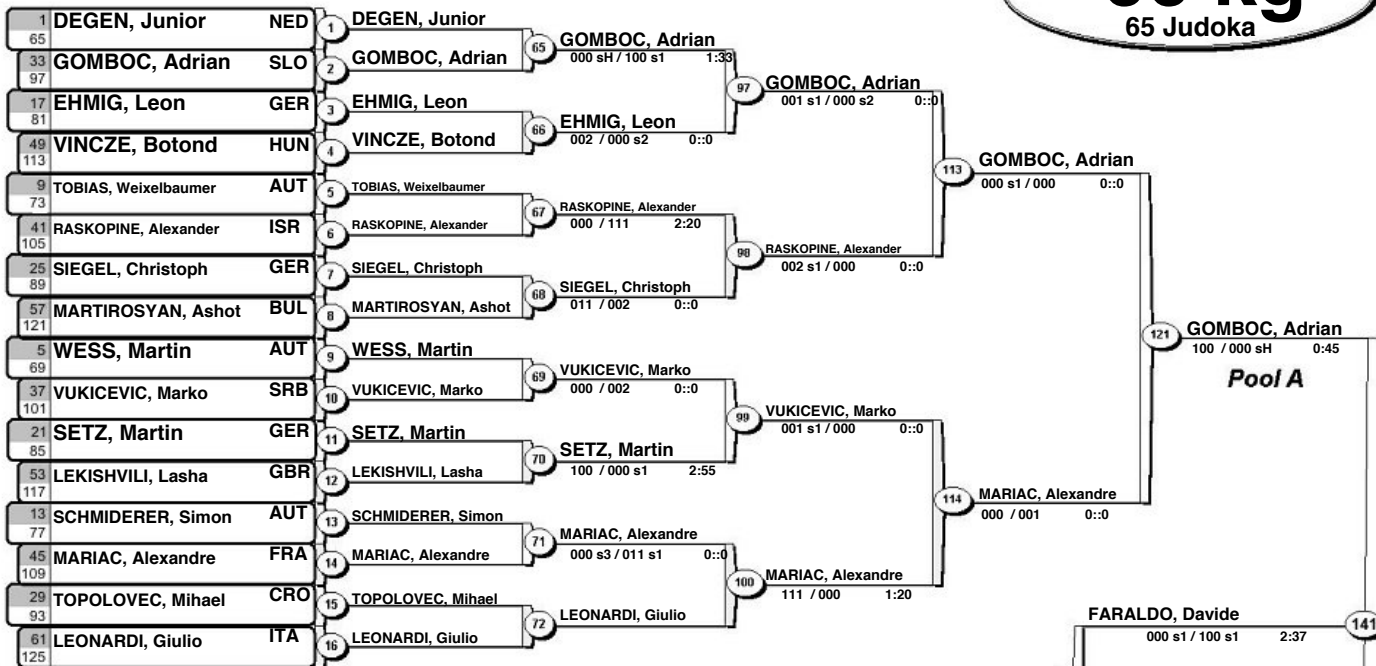

POOL B

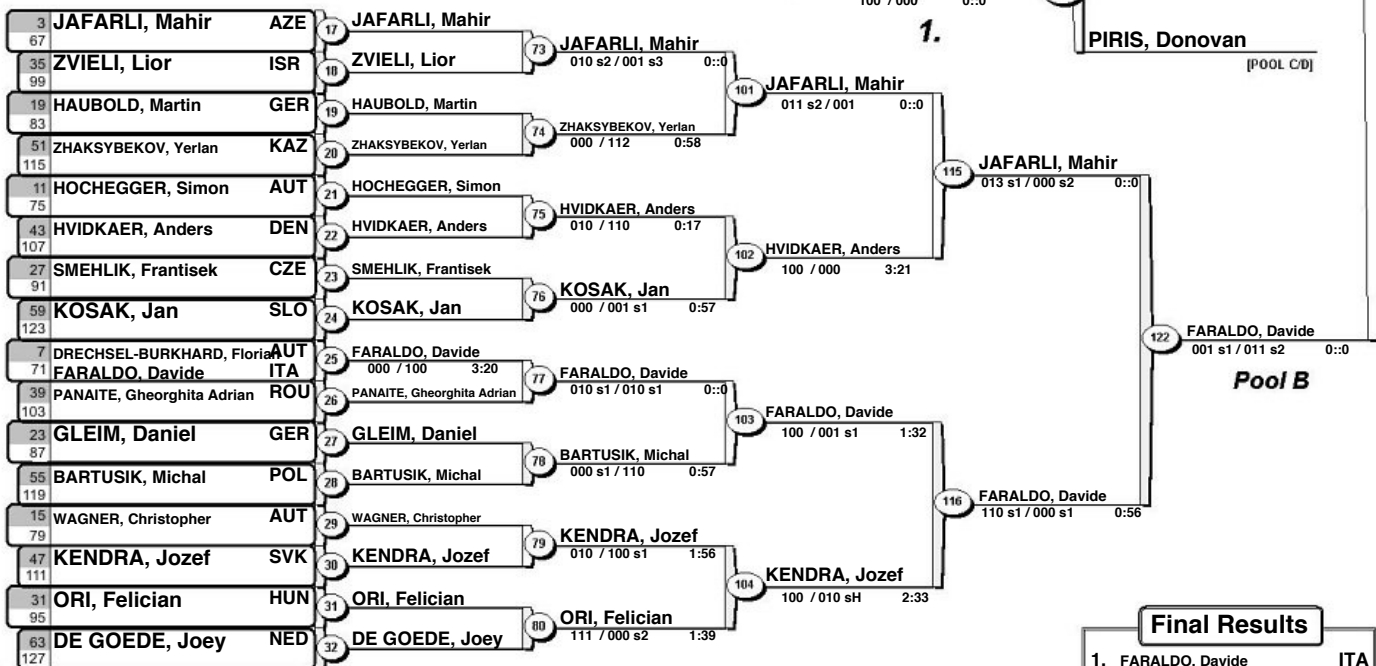

Final Results

1. FARALDO, Davide ITA
2. PIRIS, Donovan NED
3. CIGANOVIC, Ilija SRB
3. GOMBOC, Adrian SLO
5. JAFARLI, Mahir AZE
5. HENCZ, Norbert HUN
7. MARIAC, Alexandre FRA
7. HOFFMANN, Steffen GER

Repechage

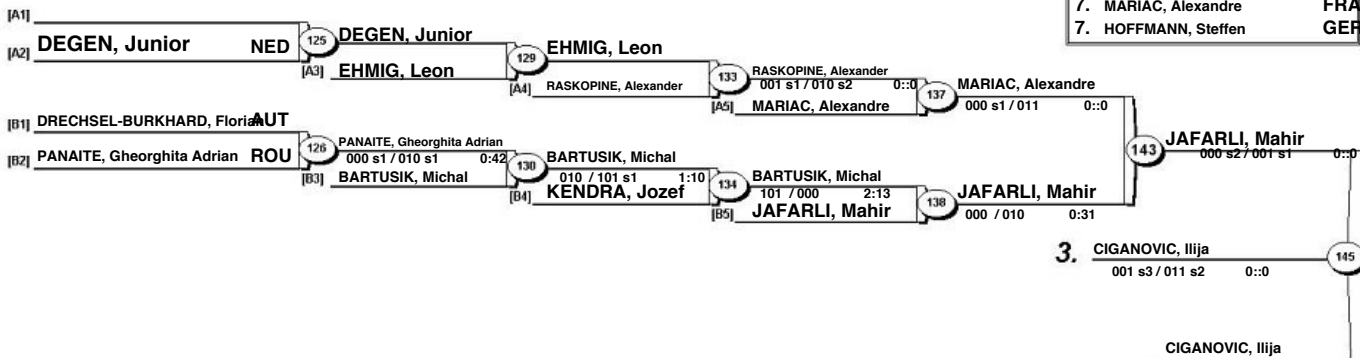



HIKU European Cup Juniors Leibnitz 2012

(AUT Leibnitz, 02-03 June 2012)

C/D

-66 kg
65 Judoka

POOL C

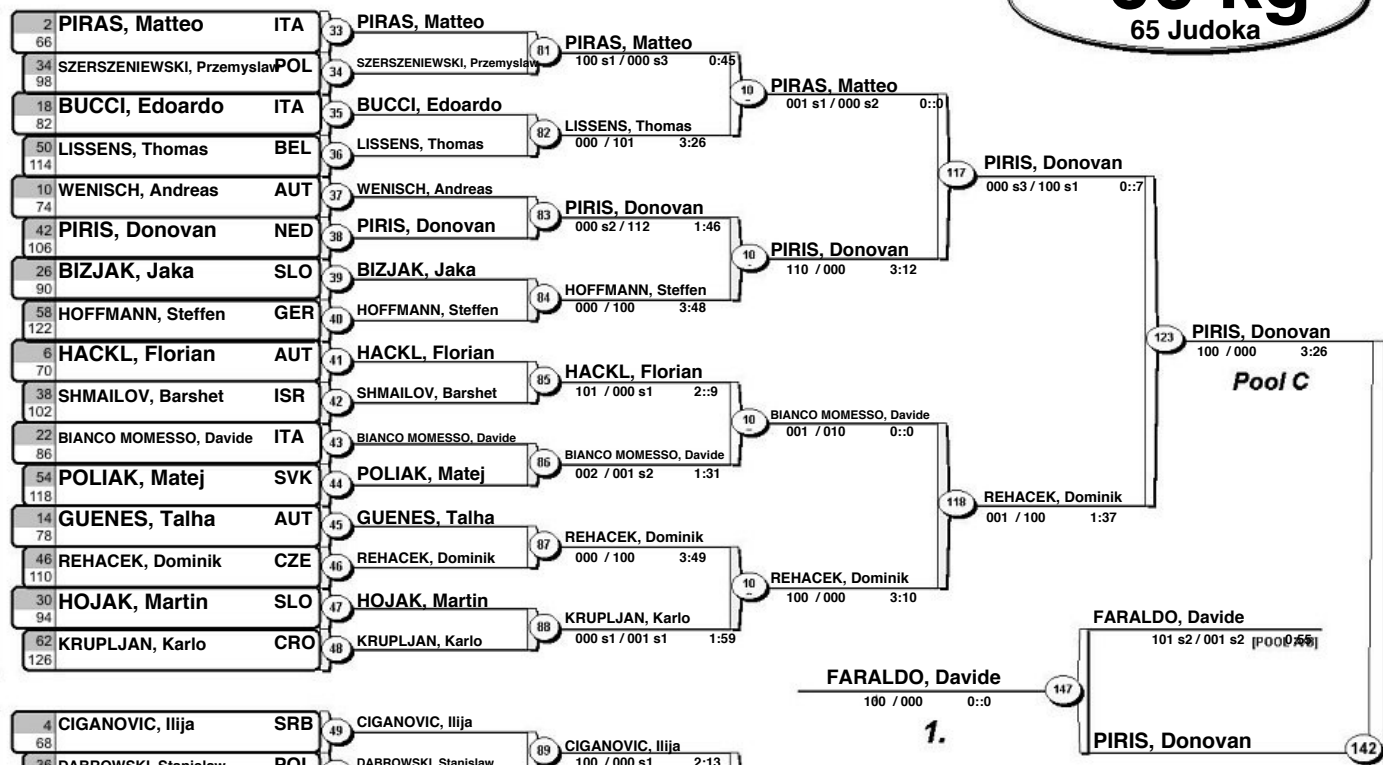

POOL D

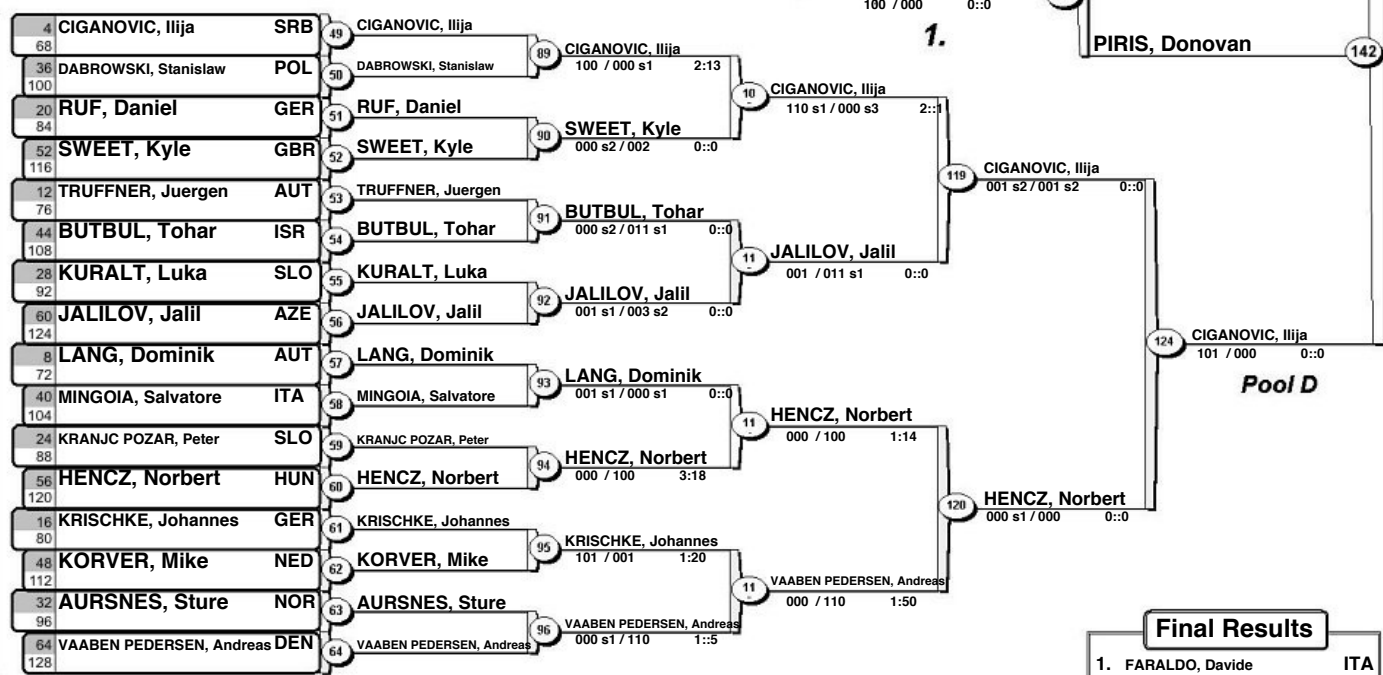

Final Results

1. FARALDO, Davide ITA
2. PIRIS, Donovan NED
3. CIGANOVIC, Ilija SRB
3. GOMBOC, Adrian SLO
5. JAFARLI, Mahir AZE
5. HENCZ, Norbert HUN
7. MARIAC, Alexandre FRA
7. HOFFMANN, Steffen GER

Repechage

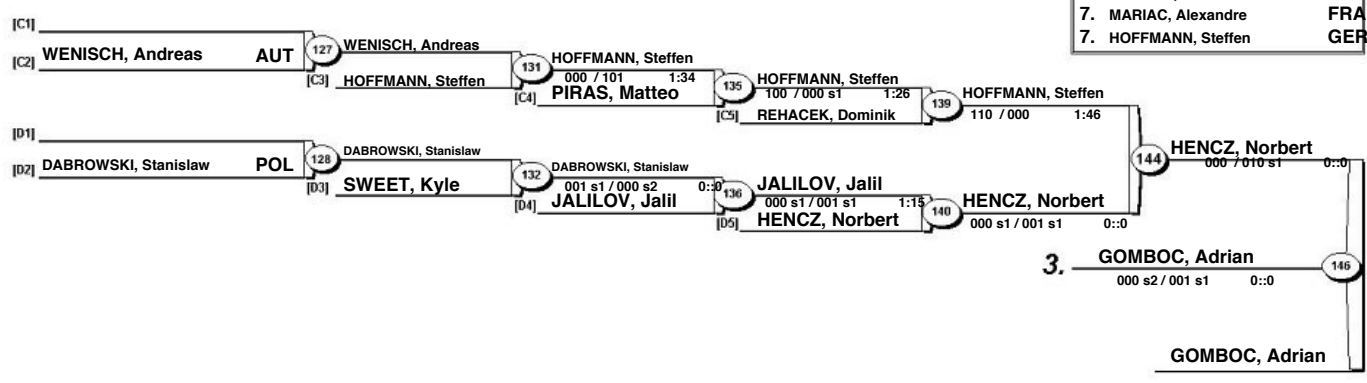



HIKU European Cup Juniors Leibnitz 2012

(AUT Leibnitz, 02-03 June 2012)

-73 kg

59 Judoka

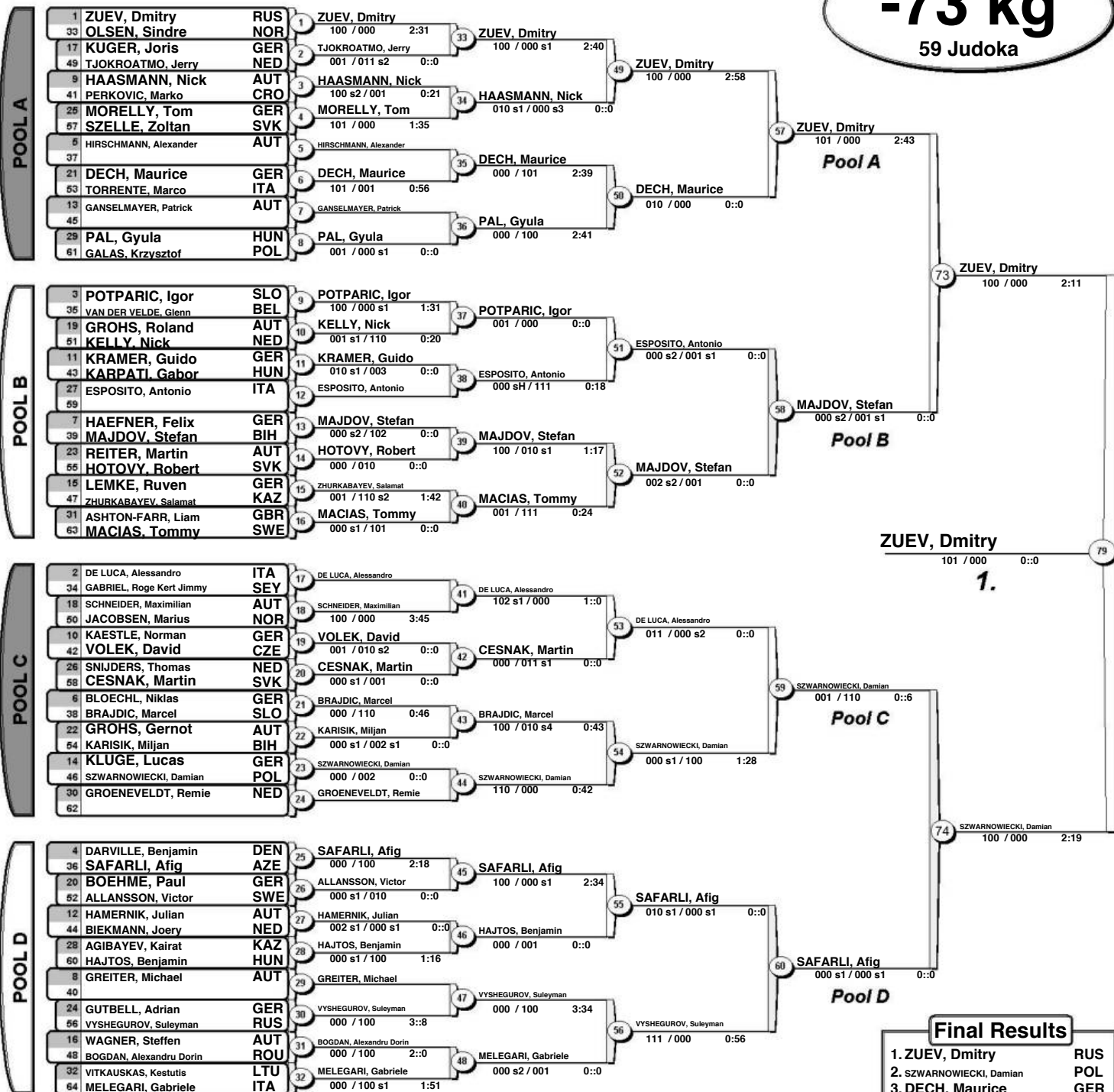

Repechage

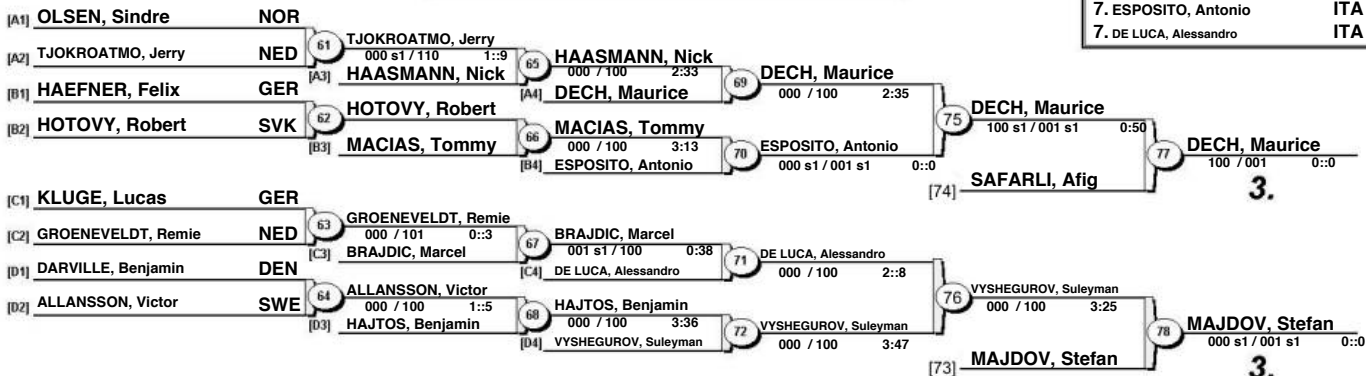



HIKU European Cup Juniors Leibnitz 2012

(AUT Leibnitz, 02-03 June 2012)

-81 kg

50 Judoka

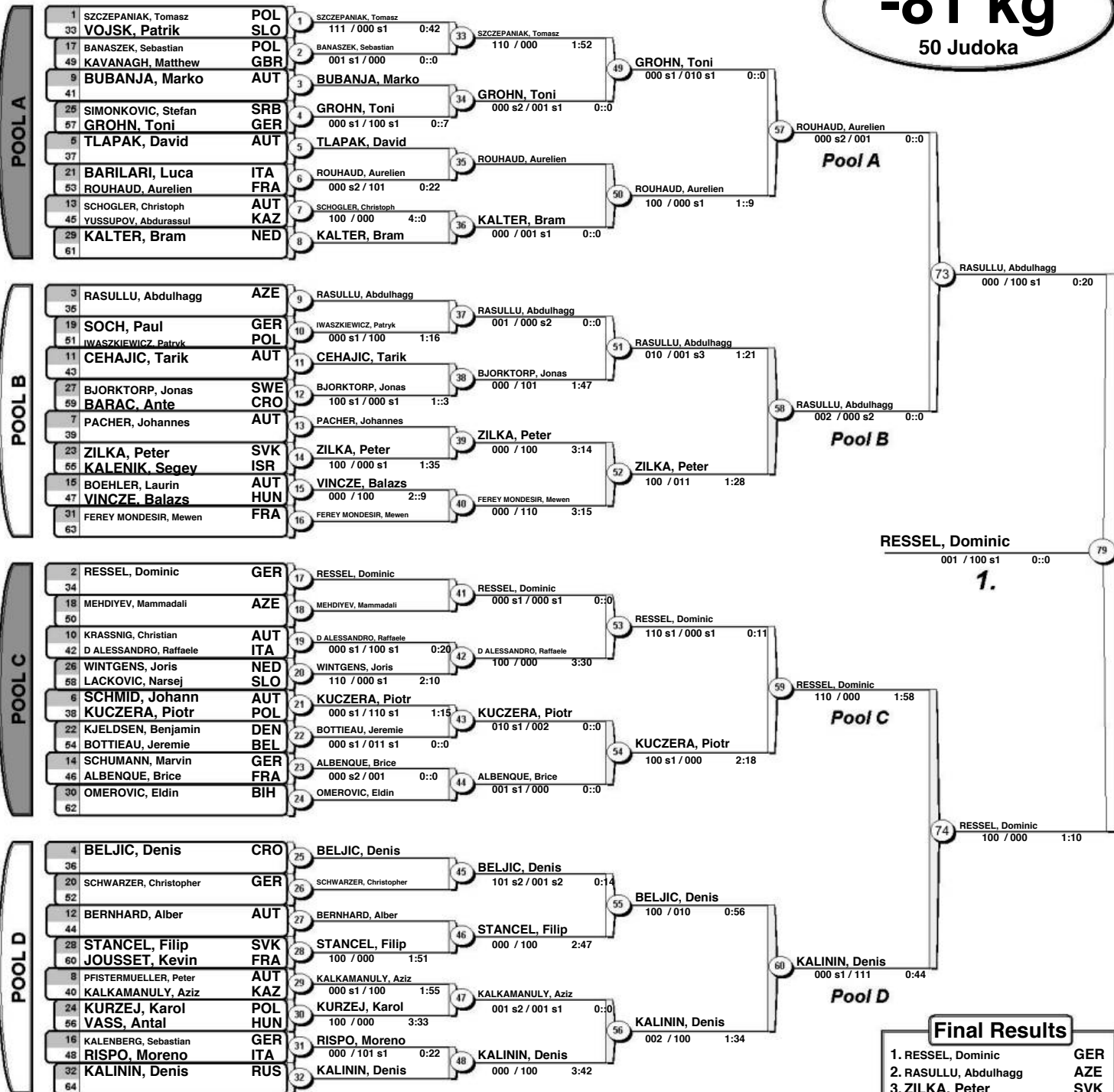

Repechage

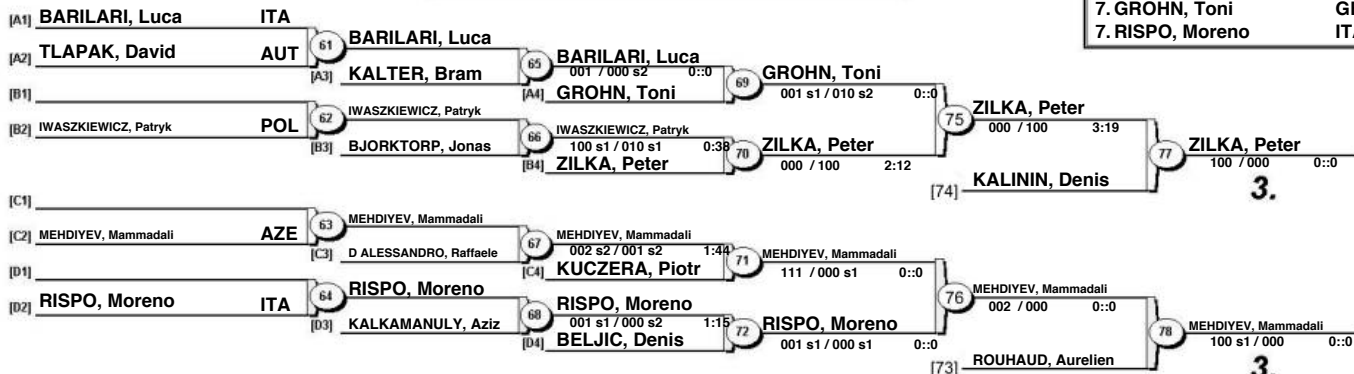



HIKU European Cup Juniors Leibnitz 2012

(AUT Leibnitz, 02-03 June 2012)

-90 kg

40 Judoka

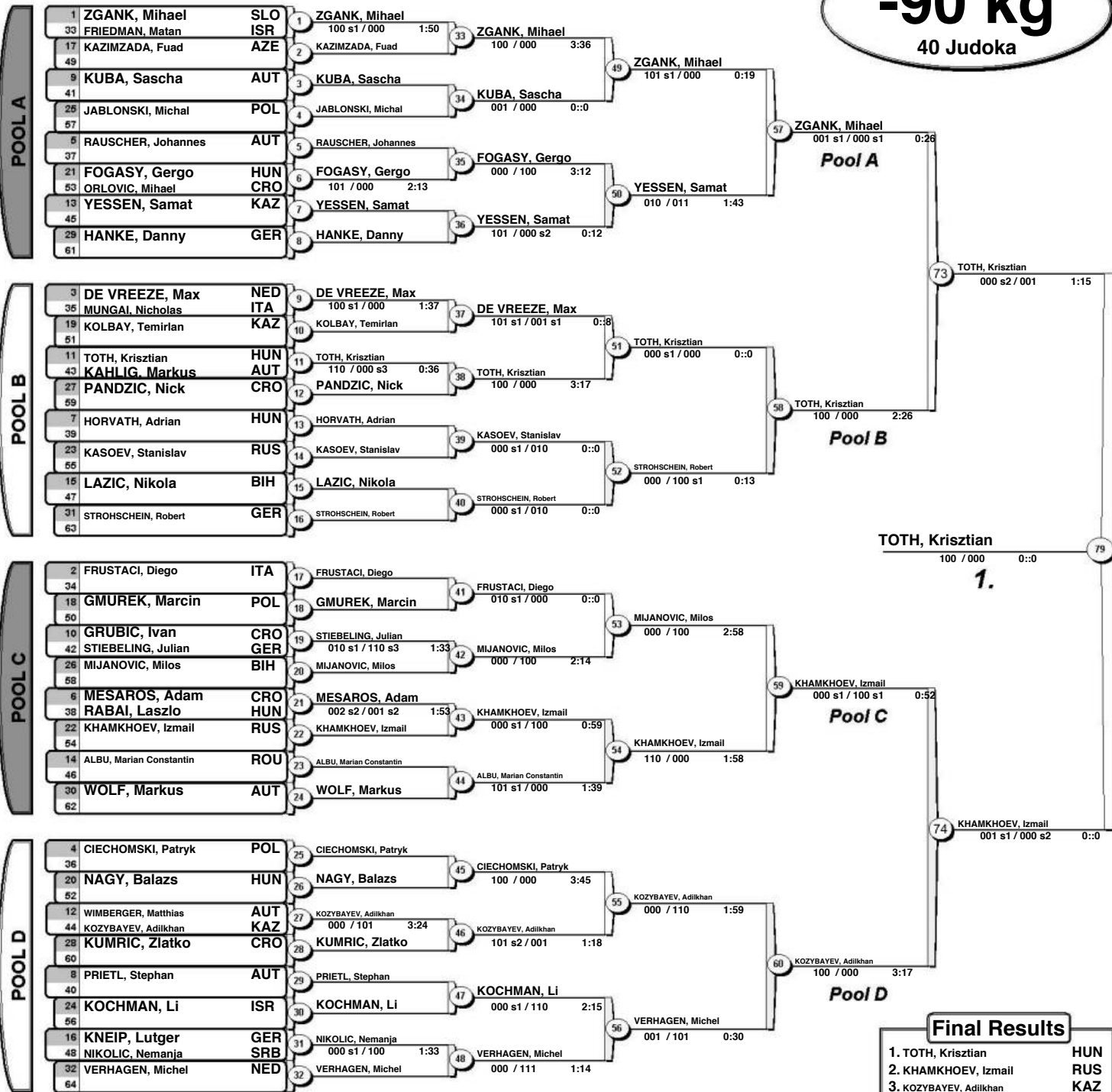

Repechage





HIKU European Cup Juniors Leibnitz 2012

(AUT Leibnitz, 02-03 June 2012)

-100 kg

23 Judoka

POOL A



Pool A - Winner
Vainqueur / Sieger

POOL B



Pool B - Winner
Vainqueur / Sieger

POOL C



Pool C - Winner
Vainqueur / Sieger

POOL D

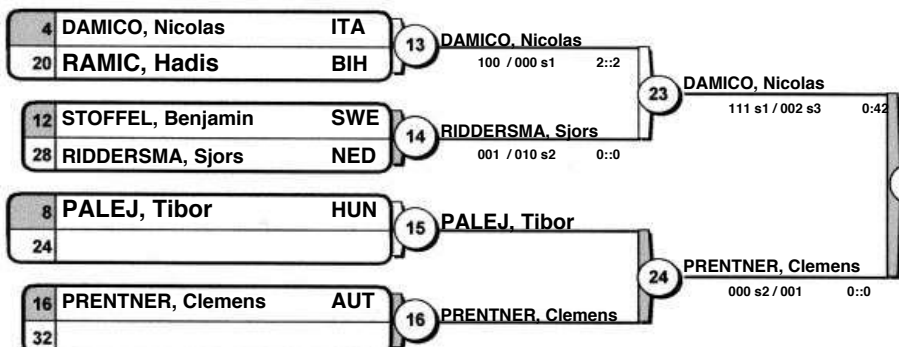

Pool D - Winner
Vainqueur / Sieger

AWITI-ALCARAZ, Philip
100 / 000 0:0

1.

38 DAMICO, Nicolas
000 / 100 2:31

Results
Résultat / Platzierungen

1. AWITI-ALCARAZ, Philip GBR
2. DAMICO, Nicolas ITA
3. SOKOLOV, Andrew RUS
4. HASANOV, Alikhan AZE
5. VAN MIERLO, Sjoerd NED
6. BUSTO, Ciro ITA
7. HAGENEDER, Maximilian AUT
8. RIDDER SMA, Sjors NED

Repechage / Trostrunde

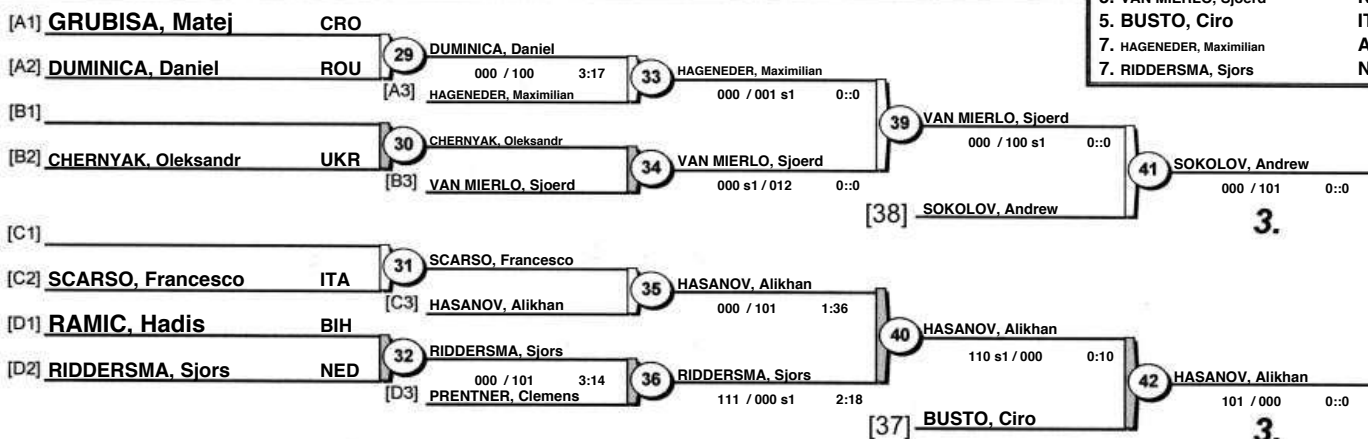

3.

3.



HIKU European Cup Juniors Leibnitz 2012

(AUT Leibnitz, 02-03 June 2012)

-44 kg

9 Judoka

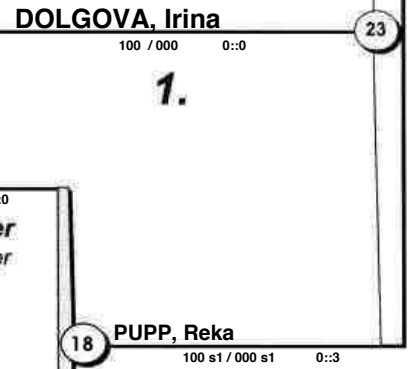
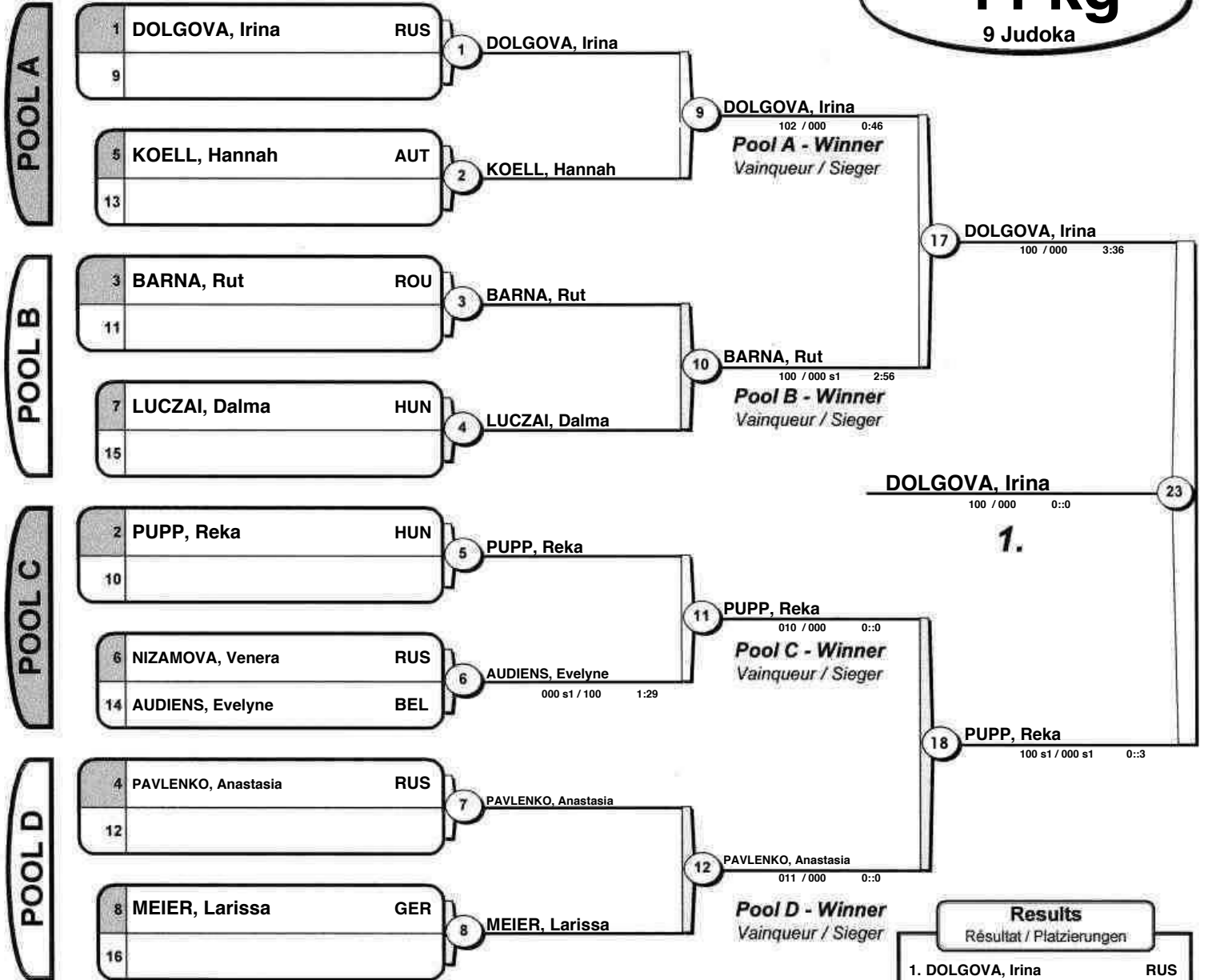

Results	
Résultat / Platzierungen	
1. DOLGOVA, Irina	RUS
2. PUPP, Reka	HUN
3. PAVLENKO, Anastasia	RUS
3. BARNA, Rut	ROU
5. LUCZAI, Dalma	HUN
5. MEIER, Larissa	GER
7. KOELL, Hannah	AUT
7. AUDIENS, Evelyne	BEL

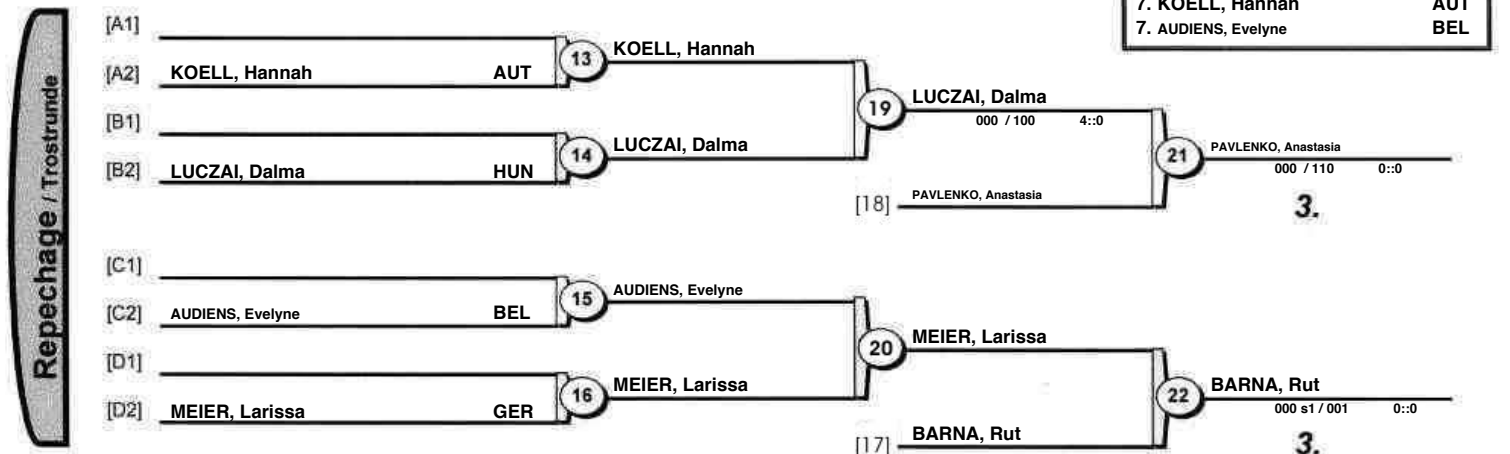



HIKU European Cup Juniors Leibnitz 2012

(AUT Leibnitz, 02-03 June 2012)

-48 kg

27 Judoka

POOL A

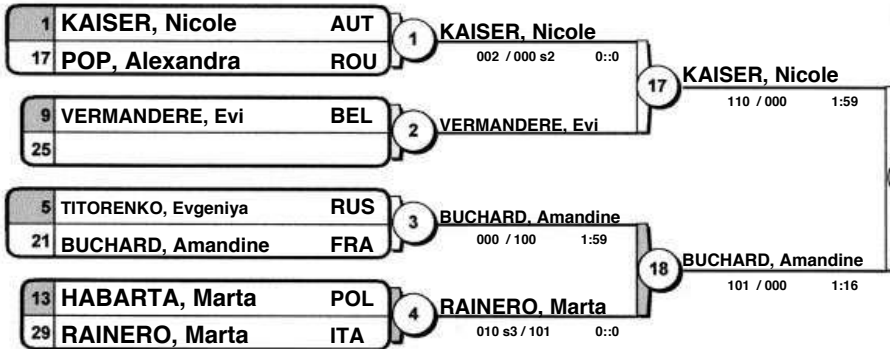

POOL B



POOL C

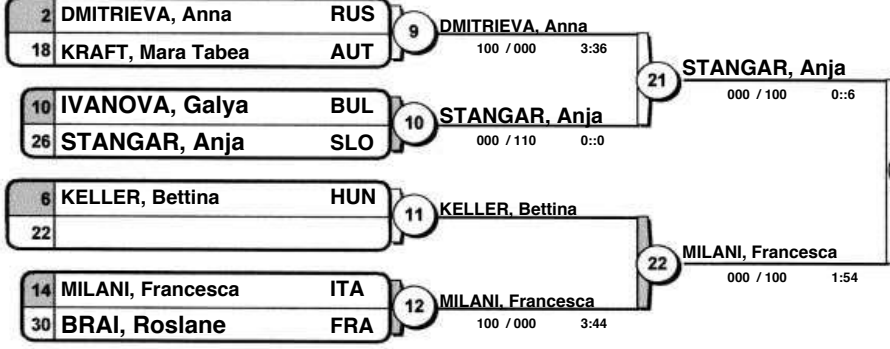

POOL D

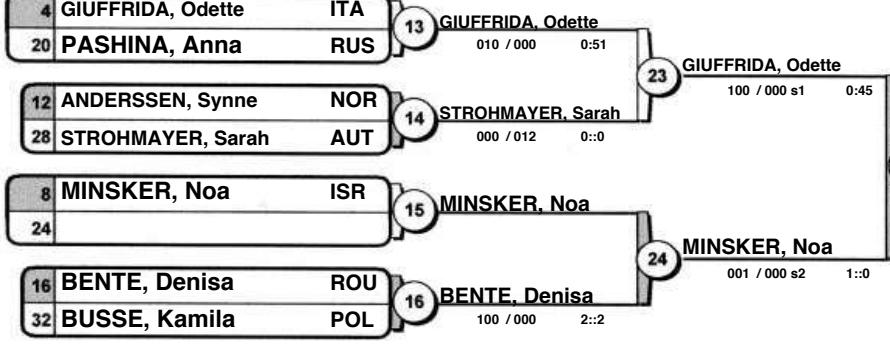

BUCHARD, Amandine
001 / 000 0:0

1.

Results	
Résultat / Platzierungen	
1.	BUCHARD, Amandine FRA
2.	STANGAR, Anja SLO
3.	KAISER, Nicole AUT
4.	BENABDELOUAHED, Sonia FRA
5.	GIUFFRIDA, Odette ITA
6.	MINSKER, Noa ISR
7.	DEMINTSEVA, Evgeniya RUS
8.	IVANOVA, Galya BUL

Repechage / Trostrunde

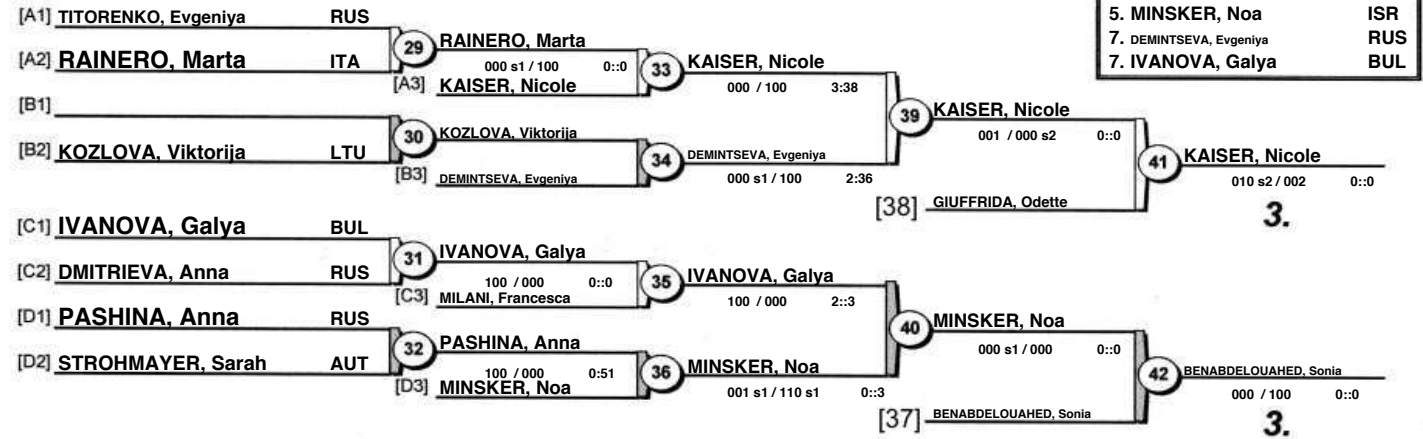

3.

3.



HIKU European Cup Juniors Leibnitz 2012

(AUT Leibnitz, 02-03 June 2012)

-52 kg

42 Judoka

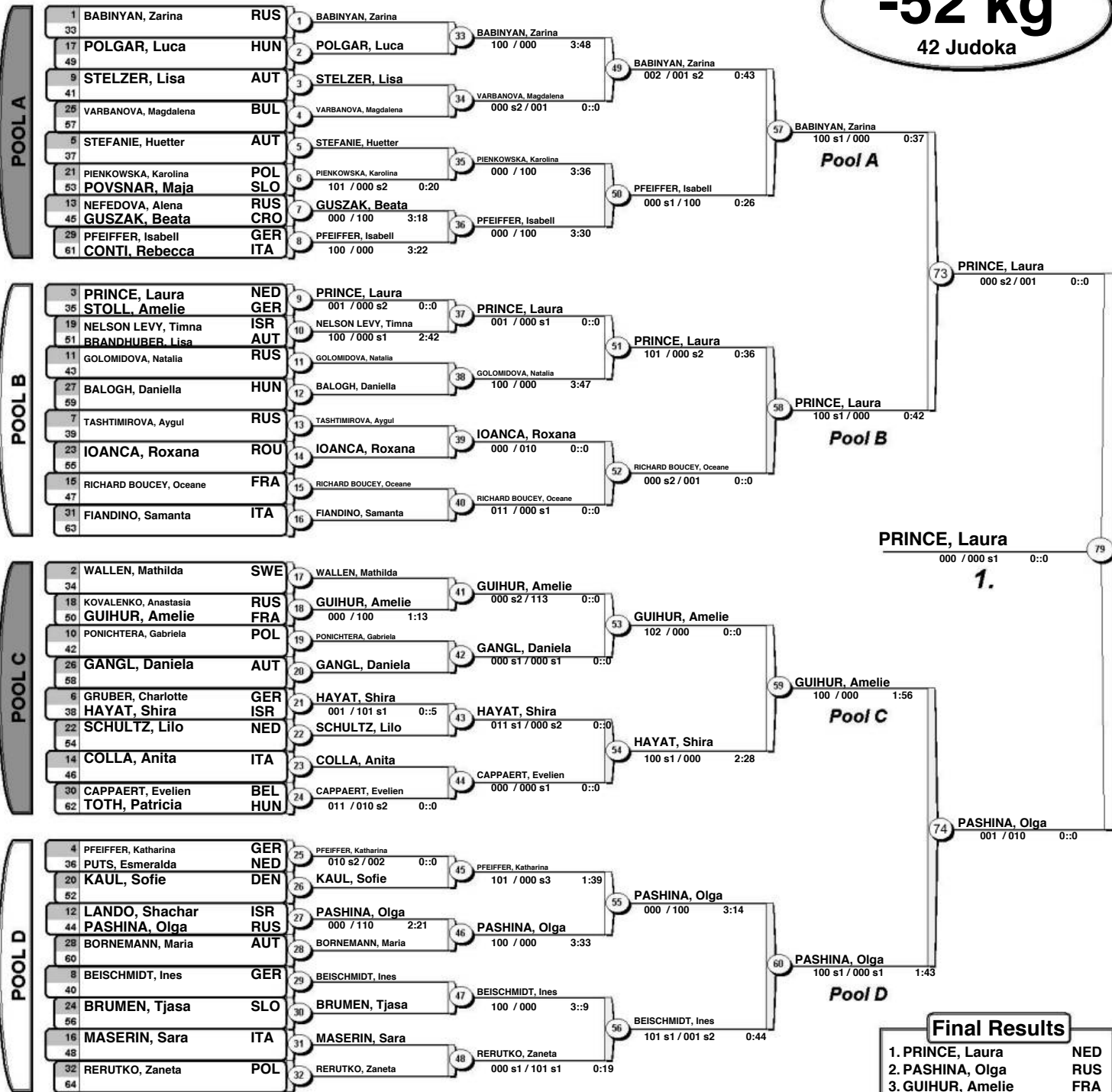

Repechage

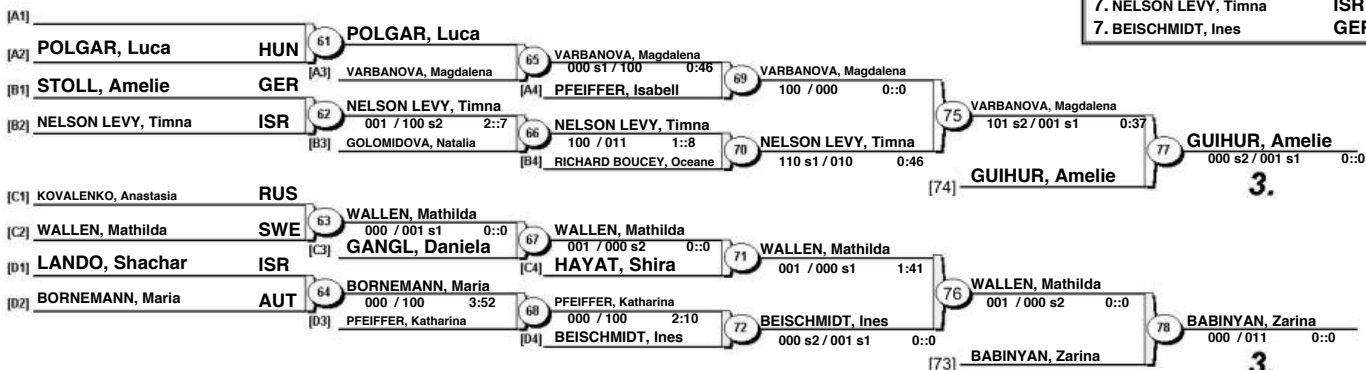



HIKU European Cup Juniors Leibnitz 2012

(AUT Leibnitz, 02-03 June 2012)

-63 kg

38 Judoka

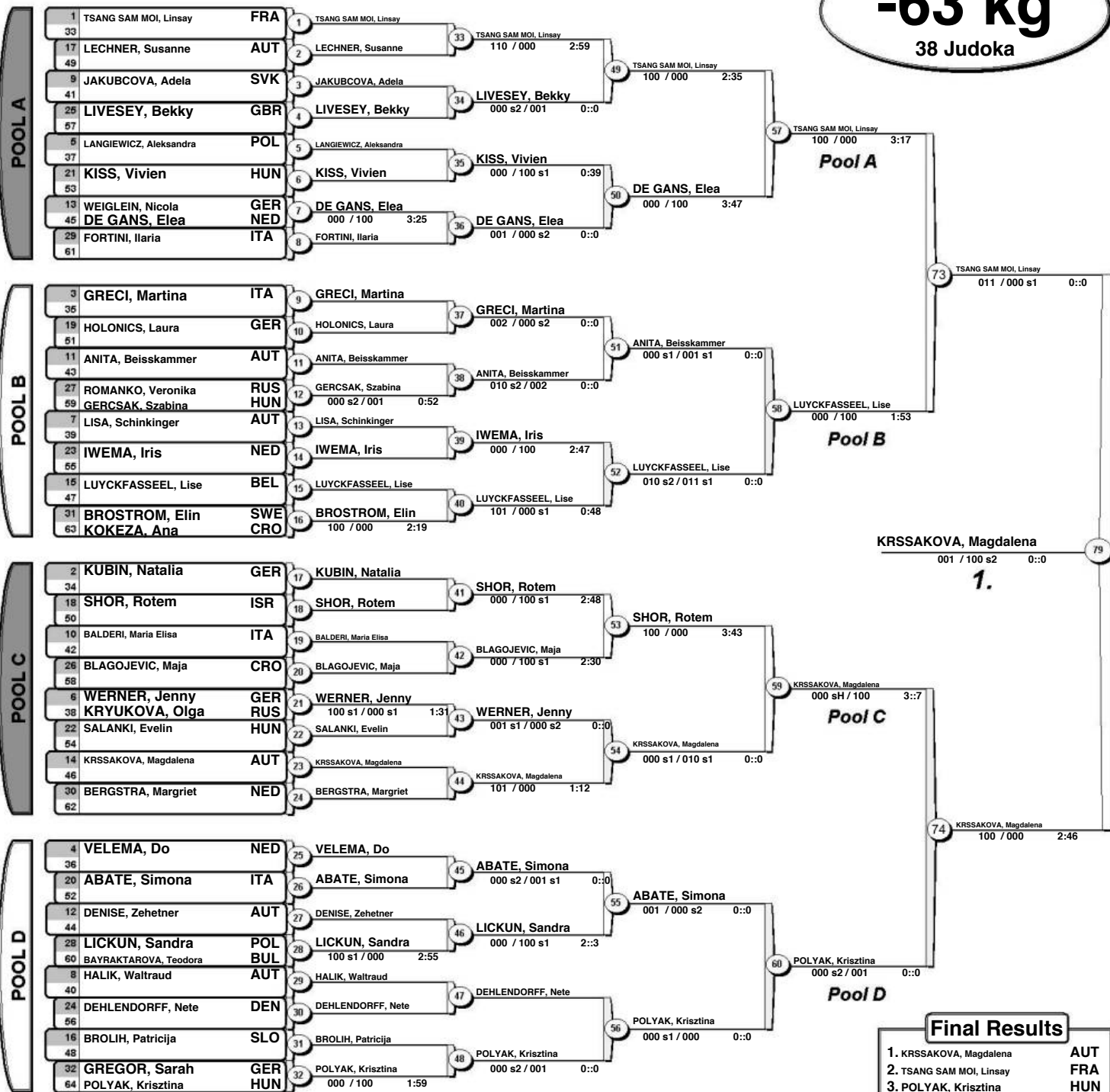

Repechage





HIKU European Cup Juniors Leibnitz 2012

(AUT Leibnitz, 02-03 June 2012)

-70 kg

29 Judoka

POOL A

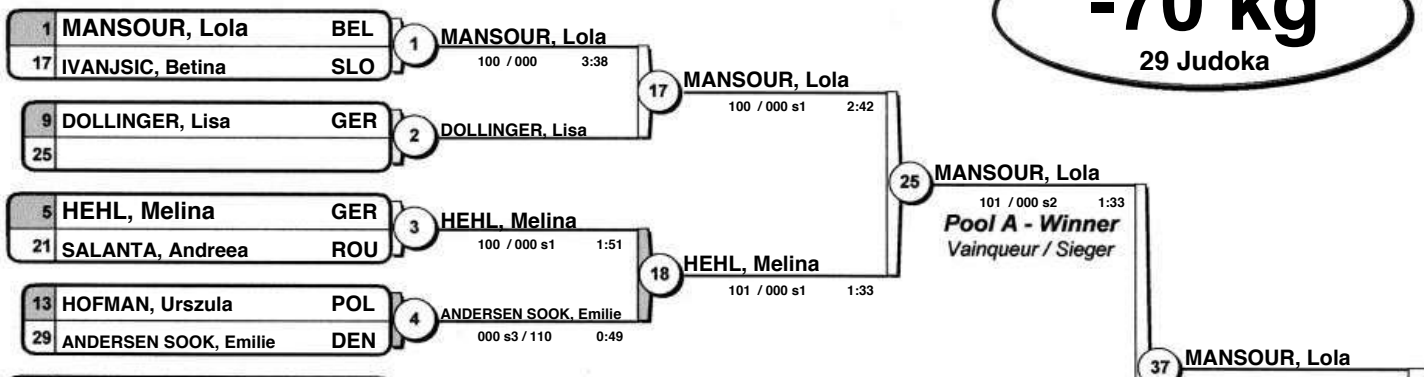

POOL B

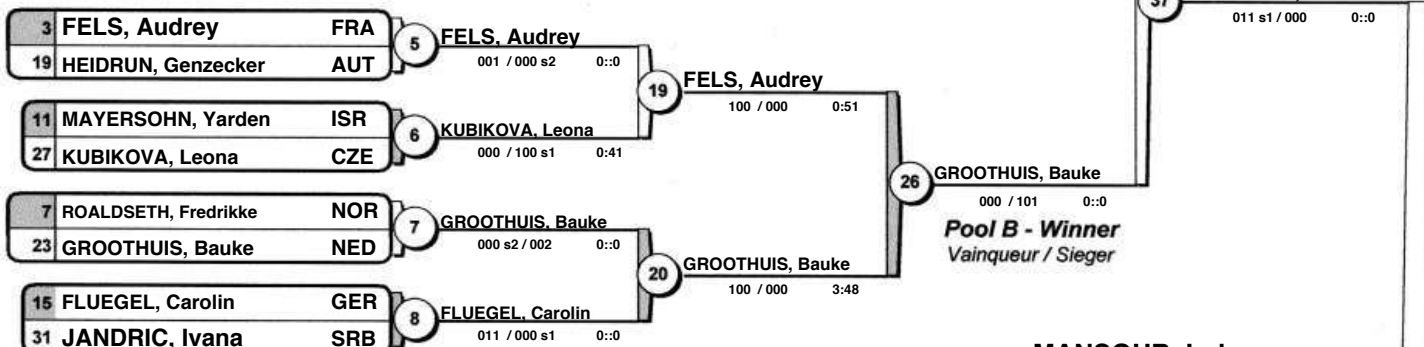

POOL C

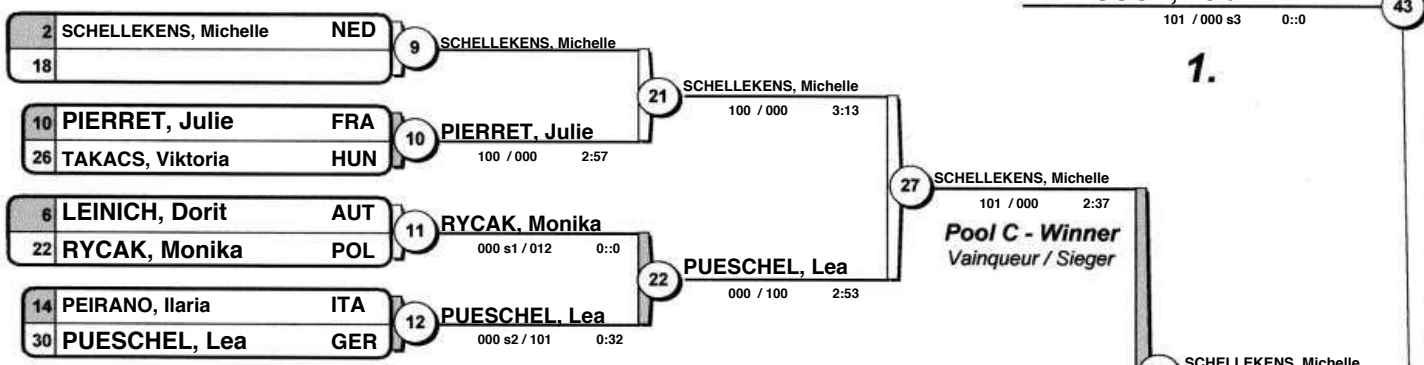

POOL D

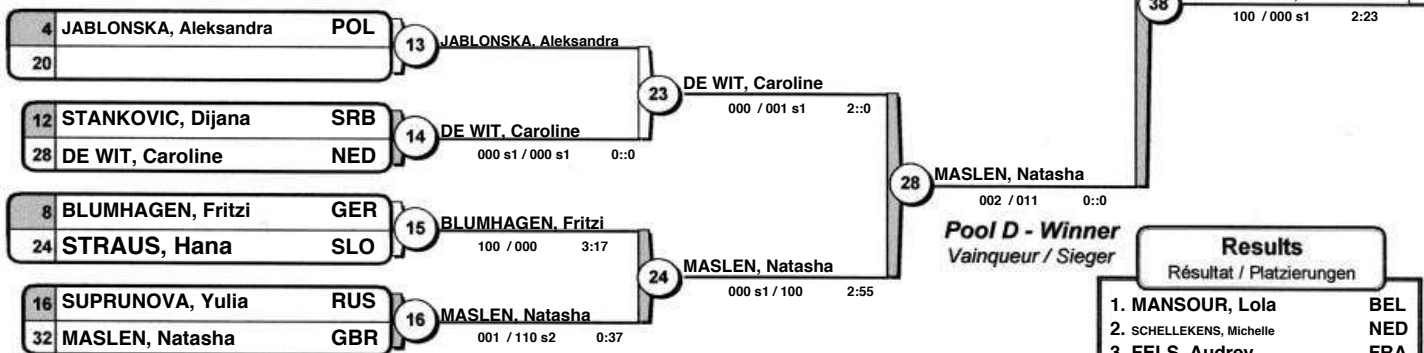

Results	
Résultat / Platzierungen	
1.	MANSOUR, Lola BEL
2.	SHELLEKENS, Michelle NED
3.	FELS, Audrey FRA
3.	PUESCHEL, Lea GER
5.	MASLEN, Natasha GBR
5.	GROOTHUIS, Bauke NED
7.	HEHL, Melina GER
7.	SUPRUNOVA, Yulia RUS

Repechage / Trostrunde

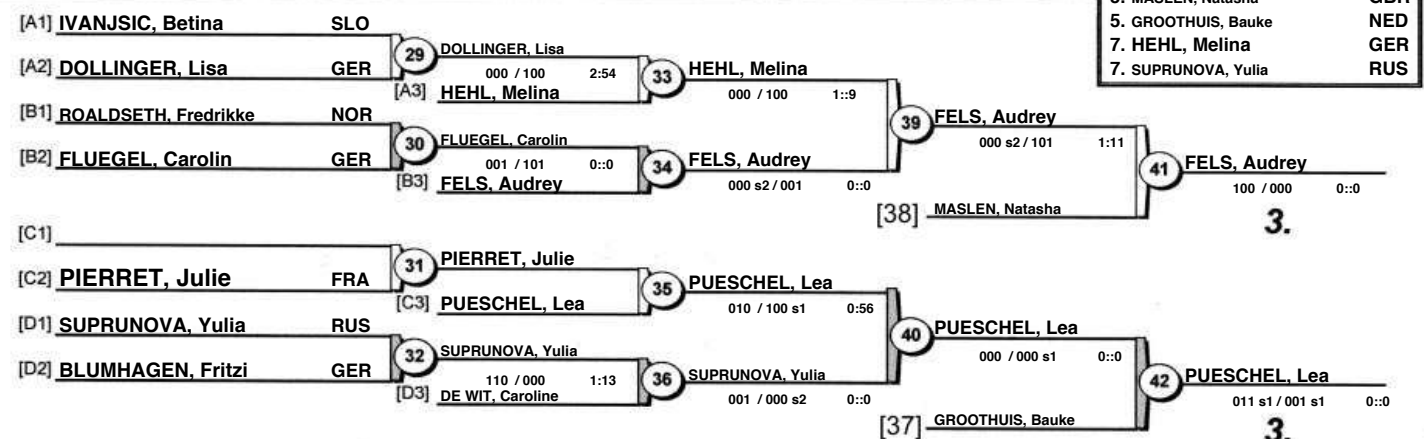



HIKU European Cup Juniors Leibnitz 2012

(AUT Leibnitz, 02-03 June 2012)

-78 kg

16 Judoka

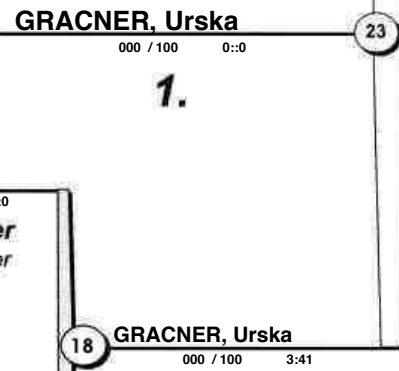
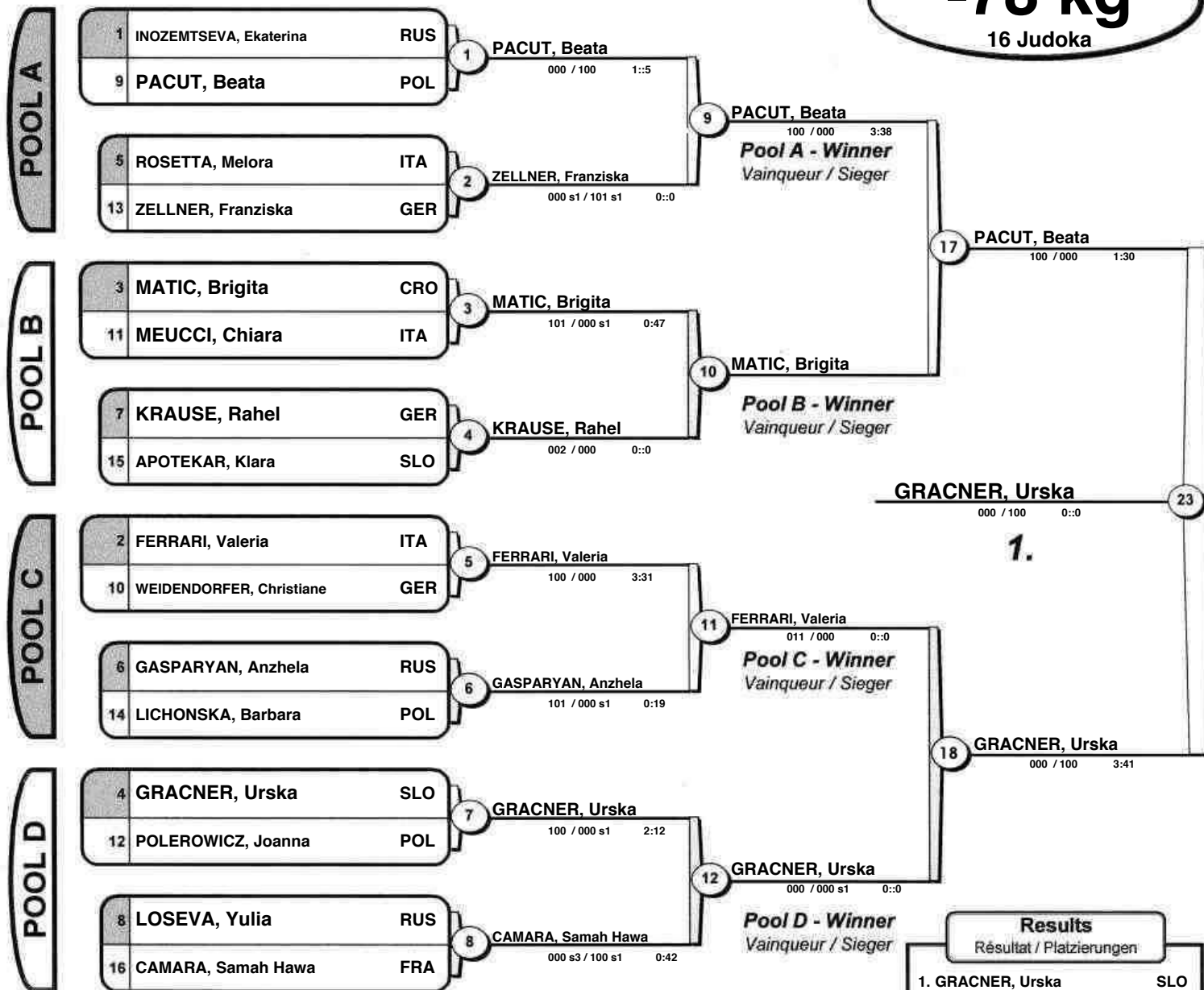

Results		
R�sultat / Platzierungen		
1.	GRACNER, Urska	SLO
2.	PACUT, Beata	POL
3.	FERRARI, Valeria	ITA
3.	MATIC, Brigita	CRO
5.	ZELLNER, Franziska	GER
5.	GASPARYAN, Anzhela	RUS
7.	KRAUSE, Rahel	GER
7.	CAMARA, Samah Hawa	FRA

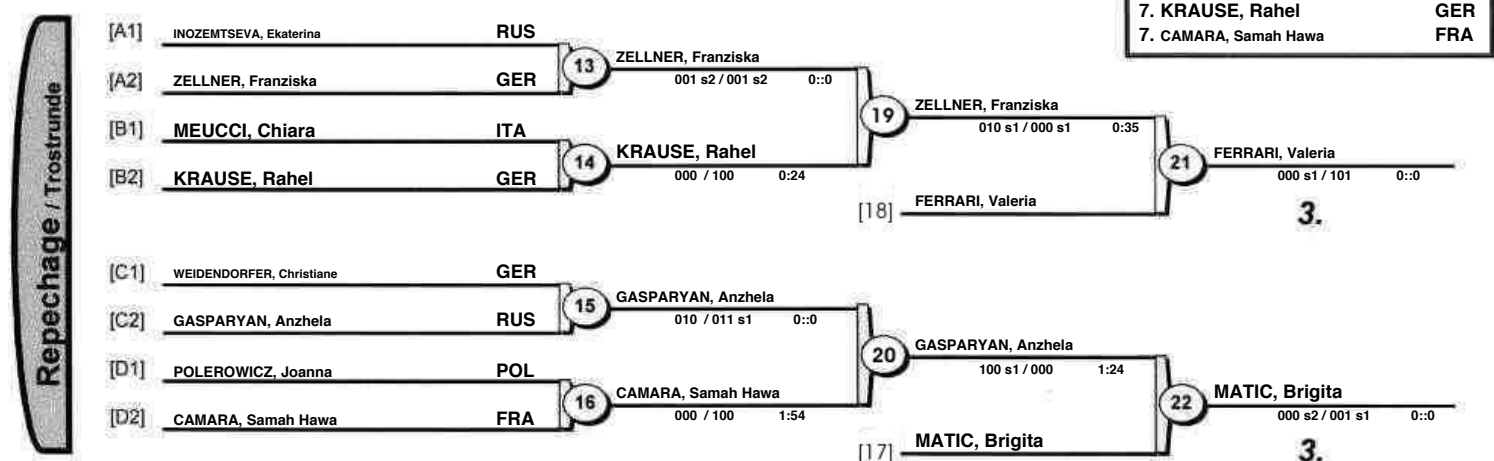



HIKU European Cup Juniors Leibnitz 2012

(AUT Leibnitz, 02-03 June 2012)

+78 kg

7 Judoka

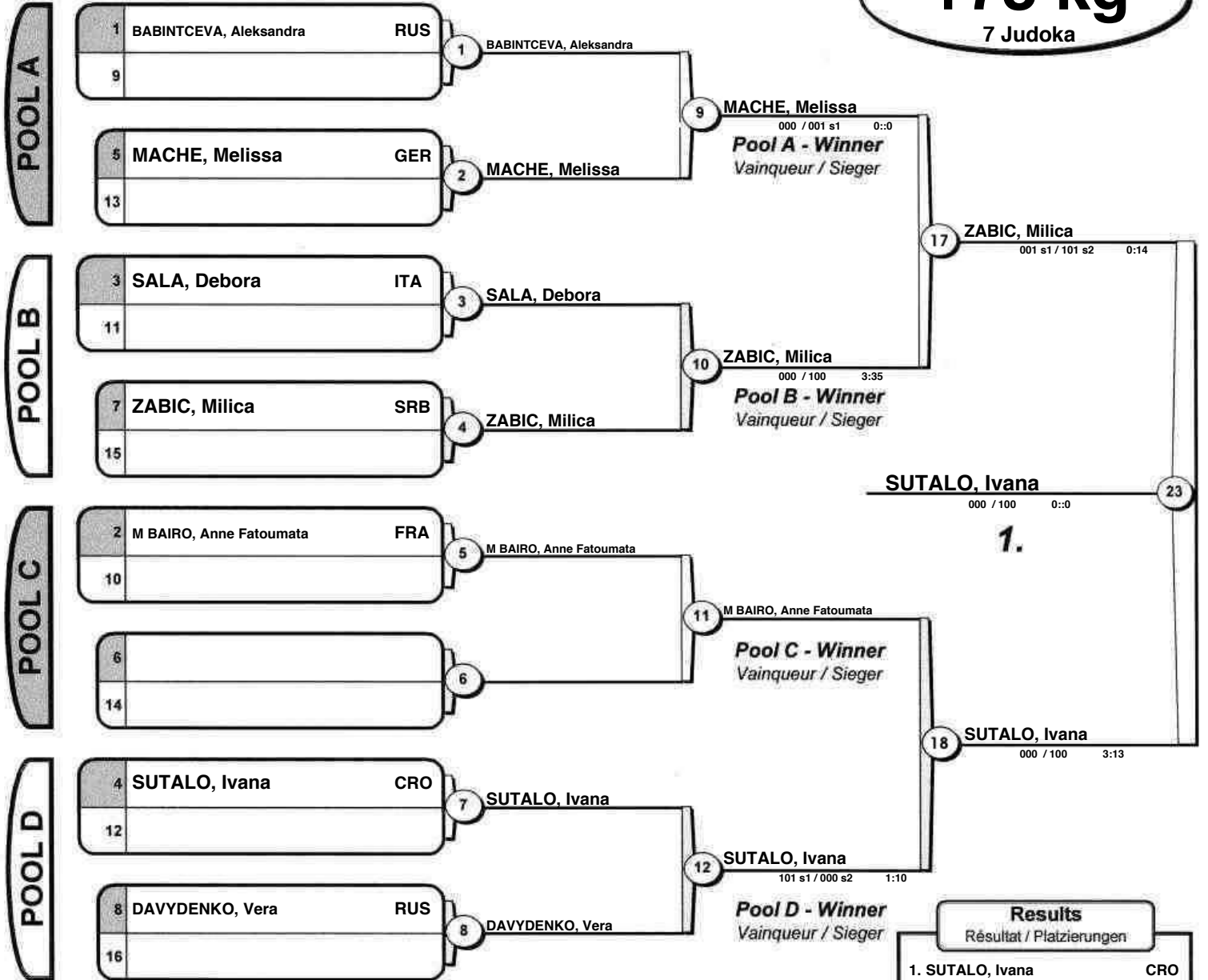

Results

Résultat / Platzierungen

- | | |
|----------------------------|-----|
| 1. SUTALO, Ivana | CRO |
| 2. ZABIC, Milica | SRB |
| 3. BABINTCEVA, Aleksandra | RUS |
| 3. DAVYDENKO, Vera | RUS |
| 5. M BAIRO, Anne Fatoumata | FRA |
| 5. MACHE, Melissa | GER |
| 7. SALA, Debora | ITA |
| 7. | |

